

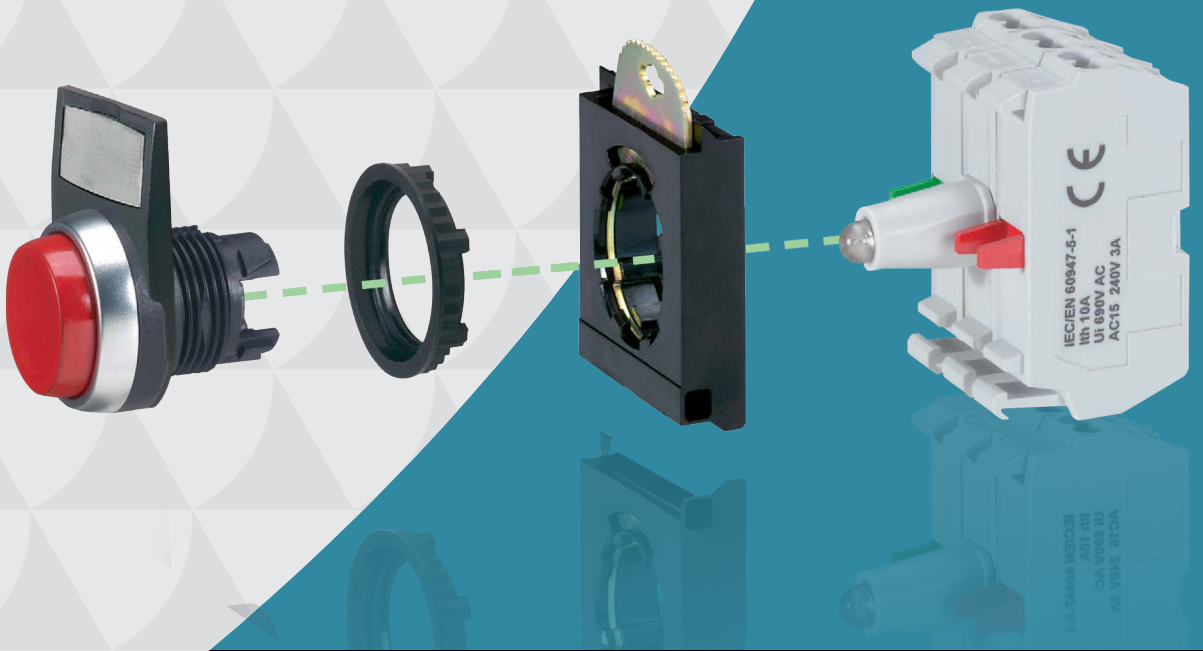













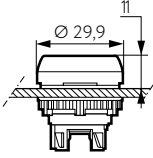

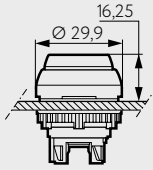

BACO®

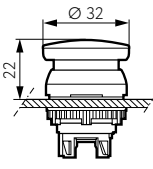

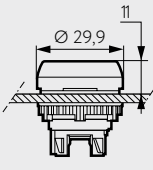

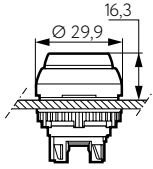
MŰKÖDTETŐ- ÉS JELZŐKÉSZÜLÉKEK  
Ø 22 mm  
BACO

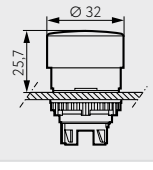

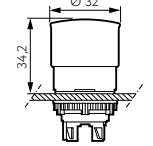



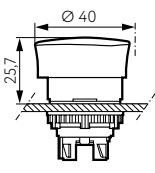

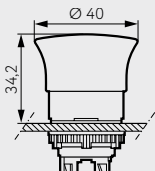

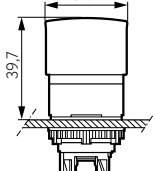

**NYOMÓGOMBOK · ALAPMÉRET: Ø 22 mm**

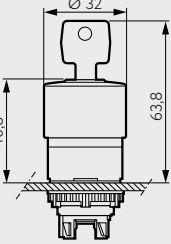
| Nem világító nyomógombok   |  |   |  |
|--|--|---|--|
| Vésett jelzés nélkül   |  <b>L21AA02</b>                     |    | <ul style="list-style-type: none"> <li><span style="color: red;">●</span> piros <b>L21AA01</b></li> <li><span style="color: green;">●</span> zöld <b>L21AA02</b></li> <li><span style="color: black;">●</span> fekete <b>L21AA03</b></li> <li><span style="color: yellow;">●</span> sárga <b>L21AA04</b></li> <li><span style="color: white;">○</span> fehér <b>L21AA05</b></li> <li><span style="color: blue;">●</span> kék <b>L21AA06</b></li> </ul> |
| Visszaálló, süllyesztett gombbal                                     | Vésett jelzéssel<br> <b>L21AA81</b> |   | <ul style="list-style-type: none"> <li><span style="color: red;">○</span> piros <b>L21AA81</b></li> <li><span style="color: green;">○</span> zöld <b>L21AA82</b></li> <li><span style="color: black;">○</span> fekete <b>L21AA83</b></li> </ul> Egyéb jelzésű változatok igényre kidolgozhatók.  |
| Színes fedőlap nélkül  |  <b>L21AA00</b>                     |   | Kiegészíthető fedőlappal<br><b>szimbólum nélkül/ szimbólummal</b>  |
| Visszaálló, kiálló gombbal   |  <b>L21AB01</b>                    |   | <ul style="list-style-type: none"> <li><span style="color: red;">●</span> piros <b>L21AB01</b></li> <li><span style="color: green;">●</span> zöld <b>L21AB02</b></li> <li><span style="color: black;">●</span> fekete <b>L21AB03</b></li> <li><span style="color: yellow;">●</span> sárga <b>L21AB04</b></li> <li><span style="color: white;">○</span> fehér <b>L21AB05</b></li> <li><span style="color: blue;">●</span> kék <b>L21AB06</b></li> </ul> |
| Visszaálló, gombafejű, Ø 32 mm                                       |  <b>L21AC03</b>                   |  | <ul style="list-style-type: none"> <li><span style="color: red;">●</span> piros <b>L21AC01</b></li> <li><span style="color: green;">●</span> zöld <b>L21AC02</b></li> <li><span style="color: black;">●</span> fekete <b>L21AC03</b></li> <li><span style="color: yellow;">●</span> sárga <b>L21AC04</b></li> </ul>  |
| Reteselt, süllyesztett gombbal                                       |  <b>L21CA01</b>                   |  | <ul style="list-style-type: none"> <li><span style="color: red;">●</span> piros <b>L21CA01</b></li> <li><span style="color: green;">●</span> zöld <b>L21CA02</b></li> <li><span style="color: black;">●</span> fekete <b>L21CA03</b></li> <li><span style="color: yellow;">●</span> sárga <b>L21CA04</b></li> <li><span style="color: white;">○</span> fehér <b>L21CA05</b></li> <li><span style="color: blue;">●</span> kék <b>L21CA06</b></li> </ul> |
| Reteselt, kiálló gombbal   |  <b>L21CB02</b>                   |  | <ul style="list-style-type: none"> <li><span style="color: red;">●</span> piros <b>L21CB01</b></li> <li><span style="color: green;">●</span> zöld <b>L21CB02</b></li> <li><span style="color: black;">●</span> fekete <b>L21CB03</b></li> <li><span style="color: yellow;">●</span> sárga <b>L21CB04</b></li> <li><span style="color: white;">○</span> fehér <b>L21CB05</b></li> <li><span style="color: blue;">●</span> kék <b>L21CB06</b></li> </ul> |
| Reteselt, gombafejű, Ø 32 mm nyomással-elfordítással visszaállítható |  <b>L22EC01</b>                   |  | <ul style="list-style-type: none"> <li><span style="color: red;">●</span> piros <b>L22EC01</b></li> <li><span style="color: green;">●</span> zöld <b>L22EC02</b></li> <li><span style="color: black;">●</span> fekete <b>L22EC03</b></li> <li><span style="color: yellow;">●</span> sárga <b>L22EC04</b></li> </ul>  |
| Reteselt, gombafejű, Ø 32 mm nyomással-húzással visszaállítható      |  <b>L22DC01</b>                   |  | <ul style="list-style-type: none"> <li><span style="color: red;">●</span> piros <b>L22DC01</b></li> </ul>  |

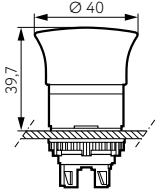

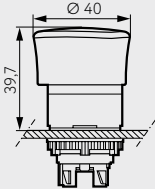

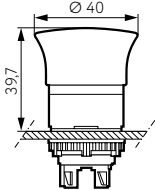

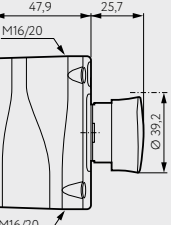



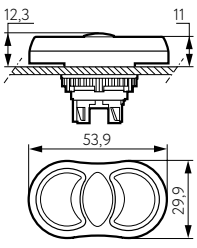













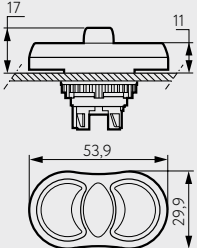

## Nem világító nyomógombok

|  |   |  |   |
|--|---|--|---|
| <p>Reteszelt, gombafejű,<br/>Ø 40 mm<br/>nyomással-elfordítással<br/>visszaállítható</p> |  <p><b>L22ED01</b></p> |  <p>Ø 40<br/>25,7</p> | <ul style="list-style-type: none"> <li><span style="color: red;">●</span> piros <b>L22ED01</b></li> <li><span style="color: green;">●</span> zöld <b>L22ED02</b></li> <li><span style="color: black;">●</span> fekete <b>L22ED03</b></li> <li><span style="color: yellow;">●</span> sárga <b>L22ED04</b></li> </ul> |
| <p>Reteszelt, gombafejű,<br/>Ø 40 mm<br/>nyomással-húzással<br/>visszaállítható</p>      |  <p><b>L22DD01</b></p> |  <p>Ø 40<br/>34,2</p> | <ul style="list-style-type: none"> <li><span style="color: red;">●</span> piros <b>L22DD01</b></li> <li><span style="color: green;">●</span> zöld <b>L22DD02</b></li> <li><span style="color: black;">●</span> fekete <b>L22DD03</b></li> <li><span style="color: yellow;">●</span> sárga <b>L22DD04</b></li> </ul> |















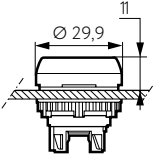







## Vészkipcsoló gombok

|   |   |  |  |
|---|---|--|--|
| <p>Reteszelt, gombafejű,<br/>Ø 32 mm<br/>nyomással-húzással<br/>visszaállítható</p>               |  <p><b>L22DQ01</b></p>   |  <p>Ø 32<br/>39,7</p>                                 | <ul style="list-style-type: none"> <li><span style="color: red;">●</span> piros <b>L22DQ01</b></li> </ul> <p>megfelel az MSZ EN ISO 13850: 2016 követelményeinek</p> |
| <p>Reteszelt, gombafejű,<br/>Ø 32 mm<br/>kulccsal visszaállítható</p>                             |  <p><b>L22GQ01</b></p>  |  <p>Ø 32<br/>40,8<br/>63,8</p>                      | <ul style="list-style-type: none"> <li><span style="color: red;">●</span> piros <b>L22GQ01</b></li> </ul> <p>megfelel az MSZ EN ISO 13850: 2016 követelményeinek</p> |
| <p>Reteszelt, gombafejű,<br/>Ø 40 mm<br/>nyomással-húzással<br/>visszaállítható</p>               |  <p><b>L22DR01</b></p> |  <p>Ø 40<br/>39,7</p>                               | <ul style="list-style-type: none"> <li><span style="color: red;">●</span> piros <b>L22DR01</b></li> </ul> <p>megfelel az MSZ EN ISO 13850: 2016 követelményeinek</p> |
| <p>Reteszelt, gombafejű,<br/>Ø 40 mm<br/>nyomással-elfordítással<br/>visszaállítható</p>          |  <p><b>L22ER01</b></p> |  <p>Ø 40<br/>39,7</p>                               | <ul style="list-style-type: none"> <li><span style="color: red;">●</span> piros <b>L22ER01</b></li> </ul> <p>megfelel az MSZ EN ISO 13850: 2016 követelményeinek</p> |
| <p>Reteszelt, gombafejű,<br/>Ø 40 mm<br/>nyomással-húzással<br/>visszaállítható,<br/>világító</p> |  <p><b>L22DN10</b></p> |  <p>Ø 40<br/>39,7</p>                               | <ul style="list-style-type: none"> <li><span style="color: red;">●</span> piros <b>L22DN10</b></li> </ul> <p>megfelel az MSZ EN ISO 13850: 2016 követelményeinek</p> |
| <p>Reteszelt, tokozott,<br/>Ø 40 mm<br/>nyomással-elfordítással<br/>visszaállítható</p>           |  <p><b>L22DN10</b></p> |  <p>47,9 25,7<br/>M16/20<br/>Ø 39,2<br/>M16/20</p> | <p><b>LBX10510</b></p> <p>Beépített 1 db<br/>NC érintkező</p>  |

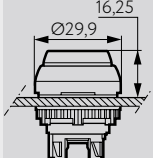









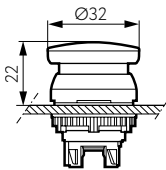

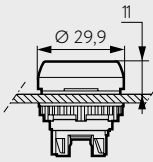
**Nyomógomb-társítás**

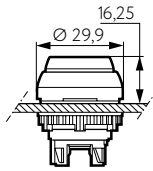

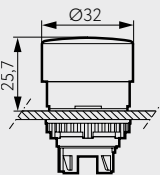

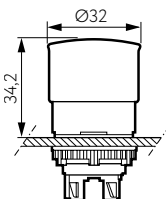

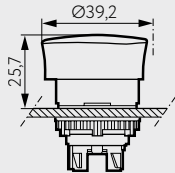

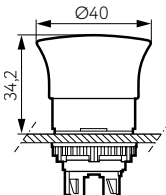

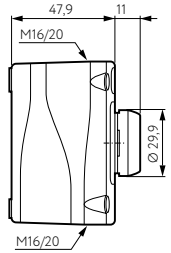
|  |  |  |
|--|--|--|
| Visszaálló kettős nyomógomb IP 66<br> | Nem világító:<br><b>L61QA21</b><br><br>Világító:<br><b>L61QH21</b><br><b>L61QK21</b> |  <ul style="list-style-type: none"> <li> <b>L61QA21</b></li> <li>  <b>L61QA22</b></li> <li>  <b>L61QA22K</b></li> <li>  <b>L61QA22K</b></li> <li>  <b>L61QA22K</b></li> <li>  <b>L61QA33C</b></li> <li>  <b>L61QA33C</b></li> </ul> |
| Visszaálló hármás nyomógomb IP 66<br> | Nem világító:<br><b>L61BA22</b>  |  <ul style="list-style-type: none"> <li> <b>L61BA22</b></li> <li>  <b>L61BA22B</b></li> <li>  <b>L61BA22B</b></li> <li>  <b>L61BA22B</b></li> <li>  <b>L61BA22B</b></li> <li>  <b>L61BA22B</b></li> </ul>   |

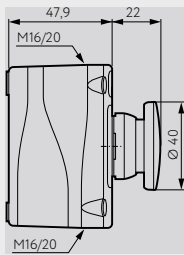
**Világító nyomógombok**

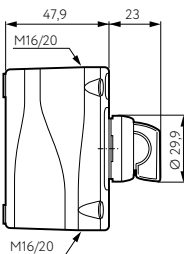
|   |   |
|---|---|
| Vésett jelzés nélkül<br>               | L21AH20<br><ul style="list-style-type: none"> <li> piros <b>L21AH10</b></li> <li> zöld <b>L21AH20</b></li> <li> sárga <b>L21AH40</b></li> <li> fehér <b>L21AH50</b></li> <li> kék <b>L21AH60</b></li> </ul>  |
| Vésett jelzéssel<br>A típusjellet a jelzés kódjával ki kell egészíteni.<br>Visszaálló, süllyesztett gombbal               |  <ul style="list-style-type: none"> <li> piros <b>L21AH31</b> ___</li> <li> zöld <b>L21AH32</b> ___</li> <li> sárga <b>L21AH34</b> ___</li> <li> fehér <b>L21AH35</b> ___</li> <li> kék <b>L21AH36</b> ___</li> </ul> |
| Színes fedőlappal<br>Visszaálló, süllyesztett gombbal   |  L21AH00   |
| Kiegészíthatő fedőlappal<br> LT20      | szimbólum nélkül/<br>szimbólummal<br><ul style="list-style-type: none"> <li> piros <b>LT10 / LT31</b> ___</li> <li> zöld <b>LT20 / LT32</b> ___</li> <li> sárga <b>LT40 / LT34</b> ___</li> <li> fehér <b>LT50 / LT35</b> ___</li> <li> kék <b>LT60 / LT36</b> ___</li> </ul>                            |
| Visszaálló, kiálló gombbal<br> L21AK20 |  <ul style="list-style-type: none"> <li> piros <b>L21AK10</b></li> <li> zöld <b>L21AK20</b></li> <li> sárga <b>L21AK40</b></li> <li> fehér <b>L21AK50</b></li> <li> kék <b>L21AK60</b></li> </ul>                     |

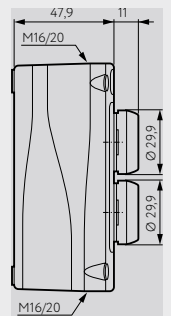

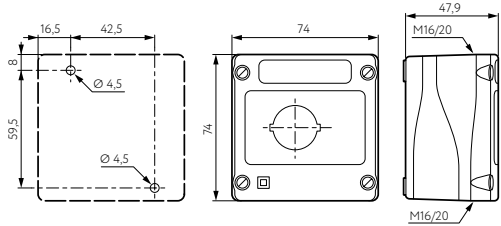

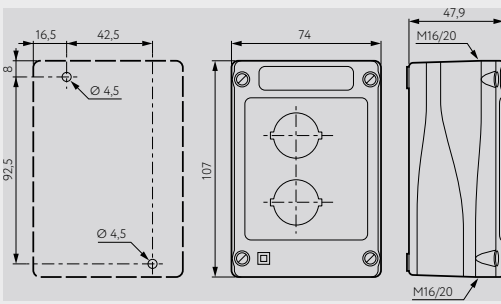

Világító nyomógombok

|  |  |   |
|--|--|---|
| <p>Visszaálló, gombafejű, Ø 32 mm</p>  |  <p>L21AL10</p>   |  <p> <span style="color: red;">●</span> piros L21AL10<br/> <span style="color: green;">●</span> zöld L21AL20<br/> <span style="color: yellow;">●</span> sárga L21AL40<br/> <span style="color: white;">○</span> fehér L21AL50         </p>  |
| <p>Reteszelt, süllyesztett gombbal</p>                                       |  <p>L21CH20</p>   |  <p> <span style="color: red;">●</span> piros L21CH10<br/> <span style="color: green;">●</span> zöld L21CH20<br/> <span style="color: yellow;">●</span> sárga L21CH40<br/> <span style="color: white;">○</span> fehér L21CH50<br/> <span style="color: blue;">●</span> kék L21CH60         </p> |
| <p>Reteszelt, kiálló gombbal</p>   |  <p>L21CK20</p>   |  <p> <span style="color: red;">●</span> piros L21CK10<br/> <span style="color: green;">●</span> zöld L21CK20<br/> <span style="color: yellow;">●</span> sárga L21CK40<br/> <span style="color: white;">○</span> fehér L21CK50<br/> <span style="color: blue;">●</span> kék L21CK60         </p> |
| <p>Reteszelt, gombafejű, Ø 32 mm nyomással-elfordítással visszaállítható</p> |  <p>L22EL10</p> |  <p> <span style="color: red;">●</span> piros L22EL10<br/> <span style="color: green;">●</span> zöld L22EL20<br/> <span style="color: yellow;">●</span> sárga L22EL40         </p>  |
| <p>Reteszelt, gombafejű, Ø 32 mm nyomással-húzással visszaállítható</p>      |  <p>L22DL10</p> |  <p> <span style="color: red;">●</span> piros L22DL10         </p>  |
| <p>Reteszelt, gombafejű, Ø 40 mm nyomással-elfordítással visszaállítható</p> |  <p>L22EM10</p> |  <p> <span style="color: red;">●</span> piros L22EM10<br/> <span style="color: green;">●</span> zöld L22EM20<br/> <span style="color: yellow;">●</span> sárga L22EM40         </p>  |
| <p>Reteszelt, gombafejű, Ø 40 mm nyomással-húzással visszaállítható</p>      |  <p>L22DM10</p> |  <p> <span style="color: red;">●</span> piros L22DM10<br/> <span style="color: green;">●</span> zöld L22DM20<br/> <span style="color: yellow;">●</span> sárga L22DM40<br/> <span style="color: white;">○</span> fehér L22DM50         </p>  |

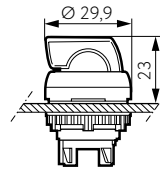



| Tokozás  |  |   |
|--|--|---|
| <p>Nem világító, visszaálló</p>  <p><b>LBX10110</b></p>                     |     | <p>● zöld <b>NO LBX10110</b></p> <p>● piros <b>NC LBX10610</b></p>  |
| <p>Nem világító, visszaálló, gombafejű, Ø 40 mm</p>  <p><b>LBX10210</b></p> |     | <p><b>LBX10210</b></p>  |
| <p>Választókapcsoló</p>  <p><b>LBX12510</b></p>                            |    | <p><b>LBX12510</b></p>  |
| <p>Visszaálló, kettős tokozott nyomógomb</p>  <p><b>LBX20120</b></p>      |   | <p><b>LBX20120</b></p>  |
|  <p><b>LBX0100J</b></p>   |  | <p>Fedél (74x74x78 mm)</p> <p>● szürke <b>LBX0100</b></p> <p>● sárga <b>LBX0100 J</b></p> <p>● fekete <b>LBX0100 N</b></p> <p>● piros <b>LBX0100 RN</b></p>   |
| <p>Üres tokok fekete alap;</p>  <p><b>LBX0200</b></p>                     |  | <p>2 furatos (74x107x48 mm)</p> <p>● szürke <b>LBX0200</b></p> <p>● sárga <b>LBX0200 J</b></p> <p>3 furatos (74x140x48 mm)</p> <p>● szürke <b>LBX0300</b></p> <p>4 furatos (74x173x48 mm)</p> <p>● szürke <b>LBX0400</b></p> <p>5 furatos (74x206x48 mm)</p> <p>● szürke <b>LBX0500</b></p> |

**VÁLASZTÓKAPCSOLÓK · ALAPMÉRET: Ø 22 mm**



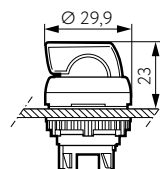



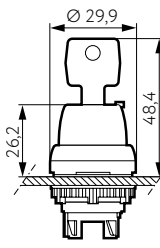

**Nem világító, kétállású kapcsolók**

|   |   |   |  |   |  |
|---|---|---|--|---|--|
|  <p><b>L21KA03</b></p> |  | Retszelt 45°<br>   | <ul style="list-style-type: none"> <li><span style="color: red;">●</span> piros <b>L21KA01</b></li> <li><span style="color: green;">●</span> zöld <b>L21KA02</b></li> <li><span style="color: black;">●</span> fekete <b>L21KA03</b></li> <li><span style="color: gray;">●</span> szürke <b>L21KA08</b></li> </ul> | Visszaálló 45°<br> | <ul style="list-style-type: none"> <li><span style="color: red;">●</span> piros <b>L21KD01</b></li> <li><span style="color: green;">●</span> zöld <b>L21KD02</b></li> <li><span style="color: black;">●</span> fekete <b>L21KD03</b></li> <li><span style="color: gray;">●</span> szürke <b>L21KD08</b></li> </ul> |
|   |   | Visszaálló 45°<br> | <ul style="list-style-type: none"> <li><span style="color: red;">●</span> piros <b>L21KB01</b></li> <li><span style="color: green;">●</span> zöld <b>L21KB02</b></li> <li><span style="color: black;">●</span> fekete <b>L21KB03</b></li> <li><span style="color: gray;">●</span> szürke <b>L21KB08</b></li> </ul> | Retszelt 90°<br>   | <ul style="list-style-type: none"> <li><span style="color: red;">●</span> piros <b>L21KE01</b></li> <li><span style="color: green;">●</span> zöld <b>L21KE02</b></li> <li><span style="color: black;">●</span> fekete <b>L21KE03</b></li> <li><span style="color: gray;">●</span> szürke <b>L21KE08</b></li> </ul> |
|   |   | Retszelt 45°<br>   | <ul style="list-style-type: none"> <li><span style="color: red;">●</span> piros <b>L21KC01</b></li> <li><span style="color: green;">●</span> zöld <b>L21KC02</b></li> <li><span style="color: black;">●</span> fekete <b>L21KC03</b></li> <li><span style="color: gray;">●</span> szürke <b>L21KC08</b></li> </ul> | Retszelt 90°<br>   | <ul style="list-style-type: none"> <li><span style="color: red;">●</span> piros <b>L21KF01</b></li> <li><span style="color: green;">●</span> zöld <b>L21KF02</b></li> <li><span style="color: black;">●</span> fekete <b>L21KF03</b></li> <li><span style="color: gray;">●</span> szürke <b>L21KF08</b></li> </ul> |

**Nem világító, háromállású kapcsolók**







|   |   |  |  |   |  |
|---|---|--|--|---|--|
|  <p><b>L21MA03</b></p> |  | Retszelt 45°<br>          | <ul style="list-style-type: none"> <li><span style="color: red;">●</span> piros <b>L21MA01</b></li> <li><span style="color: green;">●</span> zöld <b>L21MA02</b></li> <li><span style="color: black;">●</span> fekete <b>L21MA03</b></li> <li><span style="color: gray;">●</span> szürke <b>L21MA08</b></li> </ul> | Visszaálló jobbról 45°<br> | <ul style="list-style-type: none"> <li><span style="color: red;">●</span> piros <b>L21MC01</b></li> <li><span style="color: green;">●</span> zöld <b>L21MC02</b></li> <li><span style="color: black;">●</span> fekete <b>L21MC03</b></li> <li><span style="color: gray;">●</span> szürke <b>L21MC08</b></li> </ul> |
|   |   | Visszaálló balról 45°<br> | <ul style="list-style-type: none"> <li><span style="color: red;">●</span> piros <b>L21MB01</b></li> <li><span style="color: green;">●</span> zöld <b>L21MB02</b></li> <li><span style="color: black;">●</span> fekete <b>L21MB03</b></li> <li><span style="color: gray;">●</span> szürke <b>L21MB08</b></li> </ul> | Visszaálló 45°<br>         | <ul style="list-style-type: none"> <li><span style="color: red;">●</span> piros <b>L21MD01</b></li> <li><span style="color: green;">●</span> zöld <b>L21MD02</b></li> <li><span style="color: black;">●</span> fekete <b>L21MD03</b></li> <li><span style="color: gray;">●</span> szürke <b>L21MD08</b></li> </ul> |

**Nem világító, kétállású, kulcsos kapcsolók**

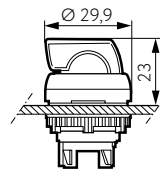



|   |   |   |  |   |  |
|---|---|---|--|---|--|
|  <p><b>L21LG00</b></p> |  | Retszelt 45°<br> | <ul style="list-style-type: none"> <li><span style="color: black;">●</span> fekete <b>L21LA00</b></li> </ul> | Visszaálló 45°<br> | <ul style="list-style-type: none"> <li><span style="color: black;">●</span> fekete <b>L21LB00</b></li> </ul> |
|   |   | Retszelt 45°<br> | <ul style="list-style-type: none"> <li><span style="color: black;">●</span> fekete <b>L21LC00</b></li> </ul> | Visszaálló 45°<br> | <ul style="list-style-type: none"> <li><span style="color: black;">●</span> fekete <b>L21LD00</b></li> </ul> |
|   |   | Retszelt 90°<br> | <ul style="list-style-type: none"> <li><span style="color: black;">●</span> fekete <b>L21LF00</b></li> </ul> | Retszelt 90°<br>   | <ul style="list-style-type: none"> <li><span style="color: black;">●</span> fekete <b>L21LG00</b></li> </ul> |
|   |   | Retszelt 90°<br> | <ul style="list-style-type: none"> <li><span style="color: black;">●</span> fekete <b>L21LH00</b></li> </ul> | Retszelt 90°<br>   | <ul style="list-style-type: none"> <li><span style="color: black;">●</span> fekete <b>L21LK00</b></li> </ul> |

Az ábrákban a pont a kulcs kihúzásának helyzetét jelöli.

**Világító, kétállású kapcsolók**

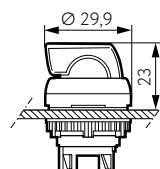
|   |   |   |   |  |   |
|---|---|---|---|--|---|
| <br><b>L21KJ30</b> |  | Reteszelt<br>45°<br> | <ul style="list-style-type: none"> <li><span style="color: red;">●</span> piros <b>L21KG10</b></li> <li><span style="color: green;">●</span> zöld <b>L21KG20</b></li> <li><span style="color: black;">●</span> fekete <b>L21KG30</b></li> </ul> | Visszaálló<br>45°<br> | <ul style="list-style-type: none"> <li><span style="color: red;">●</span> piros <b>L21KH10</b></li> <li><span style="color: green;">●</span> zöld <b>L21KH20</b></li> <li><span style="color: black;">●</span> fekete <b>L21KH30</b></li> </ul> |
|   |   | Reteszelt<br>45°<br> | <ul style="list-style-type: none"> <li><span style="color: red;">●</span> piros <b>L21KJ10</b></li> <li><span style="color: green;">●</span> zöld <b>L21KJ20</b></li> <li><span style="color: black;">●</span> fekete <b>L21KJ30</b></li> </ul> | Visszaálló<br>45°<br> | <ul style="list-style-type: none"> <li><span style="color: red;">●</span> piros <b>L21KK10</b></li> <li><span style="color: green;">●</span> zöld <b>L21KK20</b></li> <li><span style="color: black;">●</span> fekete <b>L21KK30</b></li> </ul> |
|   |   | Reteszelt<br>90°<br> | <ul style="list-style-type: none"> <li><span style="color: red;">●</span> piros <b>L21KL10</b></li> <li><span style="color: green;">●</span> zöld <b>L21KL20</b></li> <li><span style="color: black;">●</span> fekete <b>L21KL30</b></li> </ul> | Reteszelt<br>90°<br>  | <ul style="list-style-type: none"> <li><span style="color: red;">●</span> piros <b>L21KM10</b></li> <li><span style="color: green;">●</span> zöld <b>L21KM20</b></li> <li><span style="color: black;">●</span> fekete <b>L21KM30</b></li> </ul> |

**Világító, háromállású kapcsolók**





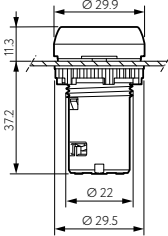



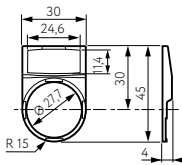

|  |   |  |   |   |   |
|--|---|--|---|---|---|
| <br><b>L21ME10</b> |  | Reteszelt<br>45°<br>          | <ul style="list-style-type: none"> <li><span style="color: red;">●</span> piros <b>L21ME10</b></li> <li><span style="color: green;">●</span> zöld <b>L21ME20</b></li> <li><span style="color: black;">●</span> fekete <b>L21ME30</b></li> </ul> | Visszaálló<br>balról 45°<br> | <ul style="list-style-type: none"> <li><span style="color: red;">●</span> piros <b>L21MF10</b></li> <li><span style="color: green;">●</span> zöld <b>L21MF20</b></li> <li><span style="color: black;">●</span> fekete <b>L21MF30</b></li> </ul> |
|  |   | Visszaálló<br>jobbról 45°<br> | <ul style="list-style-type: none"> <li><span style="color: red;">●</span> piros <b>L21MG10</b></li> <li><span style="color: green;">●</span> zöld <b>L21MG20</b></li> <li><span style="color: black;">●</span> fekete <b>L21MG30</b></li> </ul> | Visszaálló<br>45°<br>        | <ul style="list-style-type: none"> <li><span style="color: red;">●</span> piros <b>L21MH10</b></li> <li><span style="color: green;">●</span> zöld <b>L21MH20</b></li> <li><span style="color: black;">●</span> fekete <b>L21MH30</b></li> </ul> |

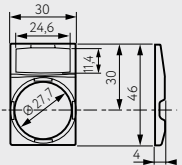
**LED JELZŐLÁMPÁK**

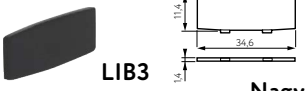
|  |   |                                      |   |  |   |
|--|---|--------------------------------------|---|--|---|
| <br><b>L20SC20L</b> |  | AC/DC<br>24 V<br>szimbólum<br>nélkül | <ul style="list-style-type: none"> <li><span style="color: red;">●</span> piros <b>L20SC10L</b></li> <li><span style="color: green;">●</span> zöld <b>L20SC20L</b></li> <li><span style="color: yellow;">●</span> sárga <b>L20SC40L</b></li> <li><span style="color: white;">○</span> fehér <b>L20SC50L</b></li> <li><span style="color: blue;">●</span> kék <b>L20SC60L</b></li> </ul> | AC/DC<br>24 V<br>szimbó-<br>lummal<br>(ld. 9.o.) | <ul style="list-style-type: none"> <li><span style="color: red;">●</span> piros <b>L20SC31L</b></li> <li><span style="color: green;">●</span> zöld <b>L20SC32L</b></li> <li><span style="color: yellow;">●</span> sárga <b>L20SC34L</b></li> <li><span style="color: white;">○</span> fehér <b>L20SC35L</b></li> <li><span style="color: blue;">●</span> kék <b>L20SC36L</b></li> </ul> |
|  |   | 130 V AC<br>szimbólum<br>nélkül      | <ul style="list-style-type: none"> <li><span style="color: red;">●</span> piros <b>L20SC10M</b></li> <li><span style="color: green;">●</span> zöld <b>L20SC20M</b></li> <li><span style="color: yellow;">●</span> sárga <b>L20SC40M</b></li> <li><span style="color: white;">○</span> fehér <b>L20SC50M</b></li> <li><span style="color: blue;">●</span> kék <b>L20SC60M</b></li> </ul> | 130 V AC<br>szimbó-<br>lummal<br>(ld. 9.o.)      | <ul style="list-style-type: none"> <li><span style="color: red;">●</span> piros <b>L20SC31M</b></li> <li><span style="color: green;">●</span> zöld <b>L20SC32M</b></li> <li><span style="color: yellow;">●</span> sárga <b>L20SC34M</b></li> <li><span style="color: white;">○</span> fehér <b>L20SC35M</b></li> <li><span style="color: blue;">●</span> kék <b>L20SC36M</b></li> </ul> |
|  |   | 230 V AC<br>szimbólum<br>nélkül      | <ul style="list-style-type: none"> <li><span style="color: red;">●</span> piros <b>L20SC10H</b></li> <li><span style="color: green;">●</span> zöld <b>L20SC20H</b></li> <li><span style="color: yellow;">●</span> sárga <b>L20SC40H</b></li> <li><span style="color: white;">○</span> fehér <b>L20SC50H</b></li> <li><span style="color: blue;">●</span> kék <b>L20SC60H</b></li> </ul> | 230 V AC<br>szimbó-<br>lummal<br>(ld. 9.o.)      | <ul style="list-style-type: none"> <li><span style="color: red;">●</span> piros <b>L20SC31H</b></li> <li><span style="color: green;">●</span> zöld <b>L20SC32H</b></li> <li><span style="color: yellow;">●</span> sárga <b>L20SC34H</b></li> <li><span style="color: white;">○</span> fehér <b>L20SC35H</b></li> <li><span style="color: blue;">●</span> kék <b>L20SC36H</b></li> </ul> |

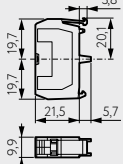

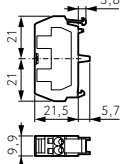
**TARTOZÉKOK**

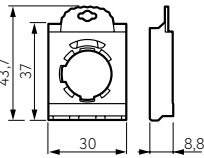
|   |   |  |
|---|---|--|
| <p>Felirati tábla, kerek</p>  <p><b>LWP31</b></p>  |    | <ul style="list-style-type: none"> <li>○ fehér <b>LWP35</b></li> <li>● piros <b>LWP31</b></li> <li>● alu <b>LWP39</b></li> <li>● fekete <b>LWP33</b></li> </ul>  |
| <p>Felirati tábla, négyzetleges</p>  <p><b>LWP4</b></p>                                      |    | <ul style="list-style-type: none"> <li>● fekete <b>LWP4</b></li> </ul>   |
| <p>Táblák</p>  <p><b>LIA1</b> Standard <b>LIB3</b> Nagy</p>                                  |    | <ul style="list-style-type: none"> <li>○ fehér <b>LIA5 / LIB5</b></li> <li>● piros <b>LIA1 / LIB1</b></li> <li>● alu <b>LIA3 / LIB3</b></li> <li>● fekete <b>LIA9 / LIB9</b></li> </ul> <p style="text-align: right;"><b>Standard / Nagy</b></p> |
| <p>Érintkező egységek csavaros csatlakozással<br/><b>Tokozáshoz</b></p>  <p><b>33E10</b></p> |    | <ul style="list-style-type: none"> <li>● zöld NO <b>33E10 / 33S10</b></li> <li>● piros NC <b>33E01 / 33S01</b></li> </ul>  |
| <p>Érintkező egységek dugaszolható csatlakozással</p>  <p><b>33R01</b></p>                 |    | <ul style="list-style-type: none"> <li>● zöld NO <b>33R10</b></li> <li>● piros NC <b>33R01</b></li> </ul>  |
| <p>Csatoló elemek</p>  <p><b>LWA0230</b> <b>333E</b></p>                                   | <p>Nyomógomb- és lámpa-fejek, valamint érintkező egységek rögzítésére</p>  | <ul style="list-style-type: none"> <li>● fekete <b>LWA0230</b><br/>1 pozíciós</li> </ul> <p>új: <b>3331</b></p> <p><b>333E</b><br/>3 pozíciós</p>  |

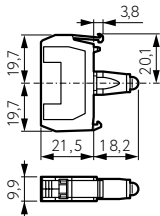
|  |   | Szín   | 24 V AC/DC                     | 130 V AC                       | 230 V AC                       |
|--|---|--|--------------------------------|--------------------------------|--------------------------------|
| <p>LED egységek csavaros csatlakozással<br/><b>Tokozáshoz</b></p>  <p><b>33EARL</b></p> |  | ○ fehér  | <b>33EAWL</b><br><b>33SAWL</b> | <b>33EAWM</b><br><b>33SAWM</b> | <b>33EAWH</b><br><b>33SAWH</b> |
|  |   | ● piros  | <b>33EARL</b><br><b>33SARL</b> | <b>33EARM</b><br><b>33SARM</b> | <b>33EARH</b><br><b>33SARH</b> |
|  |   | ● zöld   | <b>33EAGL</b><br><b>33SAGL</b> | <b>33EAGM</b><br><b>33SAGM</b> | <b>33EAGH</b><br><b>33SAGH</b> |
|  |   | ● kék  | <b>33EABL</b><br><b>33SABL</b> | <b>33EABM</b><br><b>33SABM</b> | <b>33EABH</b><br><b>33SABH</b> |
|  |   | ● sárga  | <b>33EAYL</b><br><b>33SAYL</b> | <b>33EAYM</b><br><b>33SAYM</b> | <b>33EAYH</b><br><b>33SAYH</b> |
|  |   | <p>A dugaszolható csatlakozású változatok típusjeleiben az <b>E</b> betű helyett <b>R</b> áll. Pl: <b>33RAWL</b></p> |                                |                                |                                |

**MŰSZAKI ADATOK**
**Általános adatok**

|   |          |                      |
|---|----------|----------------------|
| Környezeti hőmérséklet                                      | működési | -25 °C ...+70 °C     |
|   | tárolási | -40 °C ...+70 °C     |
| Klímaállóság  |          | MSZ EN 60068 szerint |
| Védettség általában   |          | IP 65 (MSZ EN 60529) |
| Az érintkező egységek védettsége                            |          | IP 20                |
| Nyomógombok, vészgombok, kapcsolók, LED-egységek védettsége |          | IP 69K               |
| A lámpafejek ütésállósága                                   |          | IK 05 (MSZ EN 62262) |
| Tokozott készülékek érintésvédelmi osztálya                 |          | II.                  |
| A rögzítő gyűrű meghúzási nyomatéka                         |          | 3 Nm                 |
| A csatlakozó csavarok meghúzási nyomatéka                   |          | 1,2 Nm               |
| Rezgésállóság   | 2 g      | 25 Hz-ig, 1,6 mm     |
|   | 4 g      | 25...100 Hz          |

**Érintkező egységek (csavaros és dugaszolható csatlakozás)**

|   |                                |                                 |
|---|--------------------------------|---------------------------------|
| Névleges szigetelési feszültség [U <sub>i</sub> ]           | 690 V AC                       |                                 |
| Lökőfeszültség-állóság [U <sub>imp</sub> ]                  | 6 kV                           |                                 |
| Szennyeződési fokozat                                       | 3                              |                                 |
| Névleges nyitott szerelési termikus áram [I <sub>th</sub> ] | 10 A (AC-15); 2,5 A (DC-13)    |                                 |
| Névleges üzemi áram [I <sub>e</sub> ]                       | <b>AC-15</b>                   | <b>DC-13</b>                    |
|   | 6 A (U <sub>e</sub> = 120 V)   | 0,55 A (U <sub>e</sub> = 125 V) |
|   | 3 A (U <sub>e</sub> = 240 V)   | 0,27 A (U <sub>e</sub> = 250 V) |
|   | 1,9 A (U <sub>e</sub> = 380 V) | 0,15 A (U <sub>e</sub> = 400 V) |
|   | 1,4 A (U <sub>e</sub> = 500 V) | 0,13 A (U <sub>e</sub> = 500 V) |
| Csatlakozó vezetékek keresztmetszete [mm <sup>2</sup> ]     | merev és hajlékony             | 0,5...2×2,5                     |
|   | érvéghüvellyel:                | 0,5...2×1,5                     |
| Villamos tartósság [c]                                      | 10 <sup>6</sup>                |                                 |



















**LED egységek világító lámpafejekhez**

|   |   |                                 |
|---|---|---------------------------------|
| Névleges szigetelési feszültség [U <sub>i</sub> ] | 300 V AC  |                                 |
| Lökőfeszültség-állóság [U <sub>imp</sub> ]        | 6 kV  |                                 |
| Szennyeződési fokozat                             | 3   |                                 |
| Működtető feszültség (AC, 50 Hz vagy 60 Hz)       | 12...24 V AC/DC; 48 V AC/DC; 110 V DC; 130 V AC; 230 V AC (±10 %) |                                 |
| Áramfelvétel [mA]                                 | 16...25   |                                 |
| Élettartam  | piros és sárga  | 10 <sup>5</sup> óra 25 °C-nál   |
|   | többi szín  | 5×10 <sup>4</sup> óra 25 °C-nál |

**LED jelzőlámpák (az előbbiektől eltérő adatok)**

|                            |  |                                 |
|----------------------------|--|---------------------------------|
| Működtető feszültség AC/DC | 24 V AC/DC; 130 V AC; 230 V AC (±10 %) |                                 |
| Áramfelvétel [mA]          |  | 4,6 24 V-nál                    |
|                            |  | 5,2 130 V-nál                   |
|                            |  | 4,6 230 V-nál                   |
| Élettartam                 | piros és sárga                         | 10 <sup>5</sup> óra 25 °C-nál   |
|                            | többi szín                             | 5×10 <sup>4</sup> óra 25 °C-nál |

## Leggyakoribb jelölések, szimbólumok

| Szimbólum     | Kód | Szimbólum   | Kód | Szimbólum   | Kód | Szimbólum   | Kód |
|---------------|-----|---|-----|---|-----|---|-----|
| 0 - 1         | 081 |  | A01 |  | A69 |  | B62 |
| I - II        | 082 |  | A05 |  | A70 |  | E62 |
| I - 0 - II    | 091 |  | A07 |  | A71 |  | F62 |
| I - II - III  | 092 |  | B07 |  | B01 |  | 003 |
| 0 - I - START | 093 |  | A28 |  | E01 |  | 004 |
| 0 - I - II    | 094 |  | A29 |  | F01 |  | 005 |

Megrendelésben a kódot a típusjel után kell írni.

A **GANZ Kapcsoló- és Készülékgyártó Kft.** két évtizeddel ezelőtt állapotodott meg a Strasbourban működő **BACO** céggel nyomógombok és jelzőlámpák forgalmazására.

Szeretnénk, ha a felhasználók rajtunk keresztül jobban megismernék a megoldásokat, melyek meggyőződésünk szerint a GANZ KK márkanév által elvárt minőségi szintet, kiviteli változatosságot, korszerű műszaki megoldásokat kínáló és vonzó esztétikai megjelenést képviselnek. Ezen túl az elmúlt évtizedekben bizonyítottan olyan tartósság jellemezte kivétel nélkül a BACO termékeit, amelyre nyugodtan tudják vállalni az iparágban egyedülállóan hosszú, 10 éves garanciaidőt. Így büszkén vállaljuk mi is, hogy ez a gyártmánycsalád ismét fokozottabban szerepel a kínálatunkban.

Készséggel állunk tisztelt Partnereink rendelkezésére tájékoztatással és a kívánságuk szerinti termékekkel.

GANZ KK Kft.  
menedzsmentje

▶ AUTHORIZED DISTRIBUTOR CERTIFICATE
2019

▶ We, BACO 128 Av. de Lattre-de-Tassigny – 87045 Limoges Cedex (France) confirm that:

**GANZ Kapcsoló- és Készülékgyártó Kft.**  
Kobányai út 41/c.  
H-1101 Budapest - Hungary

is the authorized distributor of the BACO products in Hungary since 1994.



▶ Trusted since 1919

Limoges  
28th of February 2019



Laurent Robert  
BACO Export Sales Manager

OUR COMMITMENT MAKES THE DIFFERENCE - **BACO®**





**GANZ Kapcsoló- és Készülékgyártó Kft.**

Cím: 1101 Budapest, Kőbányai út 41/c  
Tel.: +36 (1) 261 1115 · Fax: +36 (1) 261-7670  
Web: [www.ganzkk.hu](http://www.ganzkk.hu)  
E-mail: [ganzkk@ganzkk.hu](mailto:ganzkk@ganzkk.hu)